



LLH : LED LINEAR HIGHBAY

DESCRIPTION

A rugged, high-value LED solution for highbay and lowbay applications, replacing multi-lamp luminaires/fixtures/troffers or up to 1000 watt HID fixtures. Available with optional Xi-Fi® technology – a powerful and easy to commission wireless lighting control system.

FEATURES

- >130 lpw ultra-high efficiency delivers superior performance over fluorescent and HID, saving up to 60% of energy costs
- Universal 0-10V driver for continuous dimming

LISTINGS

- UL Listed for dry and damp locations
- DesignLights Consortium® Premium Qualified - meets the requirements for the highest DLC qualification for efficacy and lumen maintenance

PERFORMANCE

- Rated lifetime L70
>100,000 @ 40°C (104°F)
>72,000 @ 50°C (122°F)
- 4000K, 5000K CCT
- CRI: 80+

ELECTRICAL

- Input voltage: 120-277V, 347-480V
- Dimmable power supply (0-10V)
- Driver efficiency: >85%
- Power Factor: >.9
- THD: <20%
- Dimming sink current: 2mA

THERMAL

- -22°F to 122°F (-30°C to 50°C) operating temperature

CONSTRUCTION

- Heavy gauge steel body with welded frame construction resists twisting and bowing
- Diffuse frosted acrylic lens to control glare (standard) or optional clear lens for higher light output (sold separately)
- 10 ft. Y-toggle aircraft cable mounting hardware included
- Built-in 2.5kV surge protection

WARRANTY

- 5 year limited warranty; see eiko.com for warranty details

| | |
|----------------|---------|
| project name | type |
| catalog number | |
| comments | voltage |
| approved by | date |



LLH-06D/1D/2D



LLH-3D



LLH-4D/5D



LLH-7D

APPLICATIONS

- Warehouses
- Manufacturing Plants
- Distribution Centers
- Grocery Stores
- Gymsnasiums
- Indoor Recreational Facilities
- Cold Storage
- Big Box Retail
- Service Repair Centers



ORDERING INFORMATION

EXAMPLE: LLH-4D-50K-U

| Model | Lumen Package | CCT | Voltage | Controls |
|--------------------------|--|--|--|---|
| LLH : LED Linear Highbay | 06D - 65W; 8,450 lm 1D - 110W; 14,400 lm 2D - 162W; 21,000 lm 3D - 223W; 29,000 lm 4D - 265W; 34,500 lm 5D - 321W; 42,000 lm 7D - 425W; 55,000 lm | 40K - 4000K 50K - 5000K | U - 120-277V V - 347-480V | S1A - Microwave Sensor, Bi-Level Dimming w/ Ambient Light Sensor XiFi - Xi-Fi® Controls System For standalone sensors see Sensor Overview |

PERFORMANCE SUMMARY

| Order Code | Item # | Length | Watts | Nominal Lumens | LPW | CCT | Lens | Dimming | Volts | Replaces | DLC Premium |
|------------|---------------|--------|-------|----------------|-----|-------|---------|---------|----------|--------------------|-------------|
| 10568 | LLH-06D-40K-U | 2' | 65W | 8,450 | 130 | 4000K | Frosted | 0-10V | 120-277V | HBF 6x T8/4x T5 | ✓ |
| 10570 | LLH-06D-50K-U | 2' | 65W | 8,450 | 130 | 5000K | Frosted | 0-10V | 120-277V | HBF 6x T8/4x T5 | ✓ |
| 10571 | LLH-1D-40K-U | 2' | 110W | 14,400 | 130 | 4000K | Frosted | 0-10V | 120-277V | HBF 6x T8/4x T5 | ✓ |
| 10572 | LLH-1D-50K-U | 2' | 110W | 14,400 | 130 | 5000K | Frosted | 0-10V | 120-277V | HBF 6x T8/4x T5 | ✓ |
| 10573 | LLH-1D-40K-V | 2' | 110W | 14,400 | 130 | 4000K | Frosted | 0-10V | 347-480V | HBF 6x T8/4x T5 | ✓ |
| 10576 | LLH-1D-50K-V | 2' | 110W | 14,400 | 130 | 5000K | Frosted | 0-10V | 347-480V | HBF 6x T8/4x T5 | ✓ |
| 10579 | LLH-2D-40K-U | 2' | 162W | 21,000 | 130 | 4000K | Frosted | 0-10V | 120-277V | HBF 8x T8/6x T5 HO | ✓ |
| 10582 | LLH-2D-50K-U | 2' | 162W | 21,000 | 130 | 5000K | Frosted | 0-10V | 120-277V | HBF 8x T8/6x T5 HO | ✓ |
| 10585 | LLH-2D-40K-V | 2' | 162W | 21,000 | 130 | 4000K | Frosted | 0-10V | 347-480V | HBF 8x T8/6x T5 HO | ✓ |
| 10588 | LLH-2D-50K-V | 2' | 162W | 21,000 | 130 | 5000K | Frosted | 0-10V | 347-480V | HBF 8x T8/6x T5 HO | ✓ |
| 10590 | LLH-3D-40K-U | 2' | 223W | 29,000 | 130 | 4000K | Frosted | 0-10V | 120-277V | 8x T5 HO | ✓ |
| 10593 | LLH-3D-50K-U | 2' | 223W | 29,000 | 130 | 5000K | Frosted | 0-10V | 120-277V | 8x T5 HO | ✓ |
| 10595 | LLH-3D-40K-V | 2' | 223W | 29,000 | 130 | 4000K | Frosted | 0-10V | 347-480V | 8x T5 HO | ✓ |
| 10596 | LLH-3D-50K-V | 2' | 223W | 29,000 | 130 | 5000K | Frosted | 0-10V | 347-480V | 8x T5 HO | ✓ |
| 10597 | LLH-4D-40K-U | 4' | 265W | 34,500 | 130 | 4000K | Frosted | 0-10V | 120-277V | 10x T5 HO | ✓ |
| 10599 | LLH-4D-50K-U | 4' | 265W | 34,500 | 130 | 5000K | Frosted | 0-10V | 120-277V | 10x T5 HO | ✓ |
| 10602 | LLH-4D-40K-V | 4' | 265W | 34,500 | 130 | 4000K | Frosted | 0-10V | 347-480V | 10x T5 HO | ✓ |
| 10604 | LLH-4D-50K-V | 4' | 265W | 34,500 | 130 | 5000K | Frosted | 0-10V | 347-480V | 10x T5 HO | ✓ |
| 10605 | LLH-5D-40K-U | 4' | 321W | 42,000 | 130 | 4000K | Frosted | 0-10V | 120-277V | 1000W HID | ✓ |
| 10606 | LLH-5D-50K-U | 4' | 321W | 42,000 | 130 | 5000K | Frosted | 0-10V | 120-277V | 1000W HID | ✓ |
| 10607 | LLH-5D-40K-V | 4' | 321W | 42,000 | 130 | 4000K | Frosted | 0-10V | 347-480V | 1000W HID | ✓ |
| 10608 | LLH-5D-50K-V | 4' | 321W | 42,000 | 130 | 5000K | Frosted | 0-10V | 347-480V | 1000W HID | ✓ |
| 10609 | LLH-7D-40K-U | 4' | 425W | 55,000 | 130 | 4000K | Frosted | 0-10V | 120-277V | 1000W HID | ✓ |
| 10610 | LLH-7D-50K-U | 4' | 425W | 55,000 | 130 | 5000K | Frosted | 0-10V | 120-277V | 1000W HID | ✓ |
| 10611 | LLH-7D-40K-V | 4' | 425W | 55,000 | 130 | 4000K | Frosted | 0-10V | 347-480V | 1000W HID | ✓ |
| 10612 | LLH-7D-50K-V | 4' | 425W | 55,000 | 130 | 5000K | Frosted | 0-10V | 347-480V | 1000W HID | ✓ |

WITH QUICK SHIP SENSOR

| | | | | | | | | | | | |
|-------|--------------------|----|------|--------|-----|-------|---------|-------|----------|--------------------|---|
| 10616 | LLH-1D-50K-U-S1A † | 2' | 110W | 14,400 | 130 | 5000K | Frosted | 0-10V | 120-277V | HBF 6x T8/4x T5 | ✓ |
| 10618 | LLH-2D-50K-U-S1A † | 2' | 162W | 21,000 | 130 | 5000K | Frosted | 0-10V | 120-277V | HBF 8x T8/6x T5 HO | ✓ |
| 10620 | LLH-3D-50K-U-S1A † | 2' | 223W | 29,000 | 130 | 5000K | Frosted | 0-10V | 120-277V | 8x T5 HO | ✓ |

WITH Xi-Fi® WIRELESS CONTROL SYSTEM*

| | | | | | | | | | | | |
|-------|-------------------|----|------|--------|-----|-------|---------|-------|----------|--------------------|---|
| 11325 | LLH-1D-40K-U-XiFi | 2' | 110W | 14,400 | 130 | 4000K | Frosted | 0-10V | 120-277V | HBF 6x T8/4x T5 | ✓ |
| 11326 | LLH-1D-50K-U-XiFi | 2' | 110W | 14,400 | 130 | 5000K | Frosted | 0-10V | 120-277V | HBF 6x T8/4x T5 | ✓ |
| 11327 | LLH-2D-40K-U-XiFi | 2' | 162W | 21,000 | 130 | 4000K | Frosted | 0-10V | 120-277V | HBF 8x T8/6x T5 HO | ✓ |
| 11328 | LLH-2D-50K-U-XiFi | 2' | 162W | 21,000 | 130 | 5000K | Frosted | 0-10V | 120-277V | HBF 8x T8/6x T5 HO | ✓ |
| 11329 | LLH-3D-40K-U-XiFi | 2' | 223W | 29,000 | 130 | 4000K | Frosted | 0-10V | 120-277V | 8x T5 HO | ✓ |
| 11330 | LLH-3D-50K-U-XiFi | 2' | 223W | 29,000 | 130 | 5000K | Frosted | 0-10V | 120-277V | 8x T5 HO | ✓ |

✓DesignLights Consortium® Premium Qualified †Quick Ship Sensor Option - Eiko S1A Sensor *See page 3 for required Xi-Fi accessories

ADDITIONAL FACTORY INSTALLED OPTIONS

EXAMPLE: LLH-7D-50K-U-EM15W

EM15W - 15W Emergency Battery*†

EM30W - 30W Emergency Battery*†

S1A - SEN-S1A-KO Sensor*

3A - SEN-3A-KO Sensor*

3AA - SEN-3AA-KO Sensor*

3B - SEN-3B-KO Sensor*

3C - SEN-3C-KO Sensor*‡

*120-277V †120-347V only ‡347-480V only

AVAILABLE ACCESSORIES

| Order Code | Item # | Description |
|------------|-------------------------|--|
| 09226 | LLH-CHAIN | Mounting Chain for LLH, 1.05 meters (1 pair) |
| 09336 | LLH-CL-2x1 | Clear Lens for LLH-06D, 1D & 2D- 40K/50K-U |
| 09337 | LLH-CL-2x1.5 | Clear Lens for LLH-3D-40K/50K-U |
| 09338 | LLH-CL-4x1 | Clear Lens for LLH-4D & 5D-40K/50K-U |
| 09700 | LLH-CL-4x1.5 | Clear Lens for LLH-7D-40K/50K-U |
| 09339 | LLH-FL-2x1 | Frosted Lens for LLH-06D, 1D & 2D-40K/50K-U |
| 09340 | LLH-FL-2x1.5 | Frosted Lens for LLH-3D-40K/50K-U |
| 09341 | LLH-FL-4x1 | Frosted Lens for LLH-4D & 5D-40K/50K-U |
| 09701 | LLH-FL-4x1.5 | Frosted Lens for LLH-7D-40K/50K-U |
| 09227 | LLH-PENDANT BOX | Pendant Box for 120/277V LLH, 1/2" Nominal Pipe Dia. |
| 09906 | LLH-PENDANT BOX-347/480 | Pendant Box for 347/480V LLH, 1/2" Nominal Pipe Diameter |
| 09818 | LLH-SMK-1 | Surface Mount Kit, 12.6" |

| Order Code | Item # | Description |
|------------|----------------|---|
| 09819 | LLH-SMK-2 | Surface Mount Kit, 17.3" |
| 09230 | LLH-V HOOK-1 | V-Hook for LLH-06D, 1D, 2D, 4D & 5D-40K/50K-U |
| 09229 | LLH-V HOOK-1.5 | V-Hook for LLH-3D & 7D-40K/50K-U |
| 09222 | LLH-WG-2x1 | Wireguard for LLH-06D,1D & 2D-40K/50K-U |
| 09223 | LLH-WG-2x1.5 | Wireguard for LLH-3D-40K/50K-U |
| 09224 | LLH-WG-4x1 | Wireguard for LLH-4D & 5D-40K/50K-U |
| 09702 | LLH-WG-4x1.5 | Wire Guard for LLH-7D-40K/50K-U |

REQUIRED Xi-Fi ACCESSORIES

| | | |
|-------|---------------|---------------------------|
| 10893 | EC-004-2N-129 | Xi-Fi Dongle |
| 10894 | EC-018-9N-147 | Xi-Fi Precision ID Remote |

For sensor options, see EIKO Sensor Overview at eiko.com 

ACCESSORIES CROSS REFERENCE

| Order Code | Item # | Description | 06D | 1D | 2D | 3D | 4D | 5D | 7D | "U" | "V" |
|------------|-------------------------|--|-----|----|----|----|----|----|----|-----|-----|
| 09226 | LLH-CHAIN | Mounting Chain for LLH, 1.05 meters (1 pair) | ✓ | ✓ | ✓ | ✓ | ✓ | ✓ | ✓ | ✓ | ✓ |
| 09336 | LLH-CL-2x1 | Clear Lens for LLH-06D, 1D & 2D- 40K/50K-U | ✓ | ✓ | ✓ | X | X | X | X | ✓ | ✓ |
| 09337 | LLH-CL-2x1.5 | Clear Lens for LLH-3D-40K/50K-U | X | X | X | ✓ | X | X | X | ✓ | ✓ |
| 09338 | LLH-CL-4x1 | Clear Lens for LLH-4D & 5D-40K/50K-U | X | X | X | X | ✓ | ✓ | X | ✓ | ✓ |
| 09700 | LLH-CL-4x1.5 | Clear Lens for LLH-7D-40K/50K-U | X | X | X | X | X | X | ✓ | ✓ | ✓ |
| 09339 | LLH-FL-2x1 | Frosted Lens for LLH-06D, 1D & 2D-40K/50K-U | ✓ | ✓ | ✓ | X | X | X | X | ✓ | ✓ |
| 09340 | LLH-FL-2x1.5 | Frosted Lens for LLH-3D-40K/50K-U | X | X | X | ✓ | X | X | X | ✓ | ✓ |
| 09341 | LLH-FL-4x1 | Frosted Lens for LLH-4D & 5D-40K/50K-U | X | X | X | X | ✓ | ✓ | X | ✓ | ✓ |
| 09701 | LLH-FL-4x1.5 | Frosted Lens for LLH-7D-40K/50K-U | X | X | X | X | X | X | ✓ | ✓ | ✓ |
| 09227 | LLH-PENDANT BOX | Pendant Box for 120/277V LLH, 1/2" Nominal Pipe Dia. | ✓ | ✓ | ✓ | ✓ | ✓ | ✓ | ✓ | ✓ | X |
| 09906 | LLH-PENDANT BOX-347/480 | Pendant Box for 347/480V LLH, 1/2" Nominal Pipe Diameter | ✓ | ✓ | ✓ | ✓ | ✓ | ✓ | ✓ | X | ✓ |
| 09818 | LLH-SMK-1 | Surface Mount Kit, 12.6" | ✓ | ✓ | ✓ | X | ✓ | ✓ | X | ✓ | ✓ |
| 09819 | LLH-SMK-2 | Surface Mount Kit, 17.3" | X | X | X | ✓ | X | X | ✓ | ✓ | ✓ |
| 09230 | LLH-V HOOK-1 | V-Hook for LLH-06D, 1D, 2D, 4D & 5D-40K/50K-U | ✓ | ✓ | ✓ | X | ✓ | ✓ | X | ✓ | ✓ |
| 09229 | LLH-V HOOK-1.5 | V-Hook for LLH-3D & 7D-40K/50K-U | X | X | X | ✓ | X | X | ✓ | ✓ | ✓ |
| 09222 | LLH-WG-2x1 | Wireguard for LLH-06D,1D & 2D-40K/50K-U | ✓ | ✓ | ✓ | X | X | X | X | ✓ | ✓ |
| 09223 | LLH-WG-2x1.5 | Wireguard for LLH-3D-40K/50K-U | X | X | X | ✓ | X | X | X | ✓ | ✓ |
| 09224 | LLH-WG-4x1 | Wireguard for LLH-4D & 5D-40K/50K-U | X | X | X | X | ✓ | ✓ | X | ✓ | ✓ |
| 09702 | LLH-WG-4x1.5 | Wire Guard for LLH-7D-40K/50K-U | X | X | X | X | X | X | ✓ | ✓ | ✓ |

DIMENSIONS

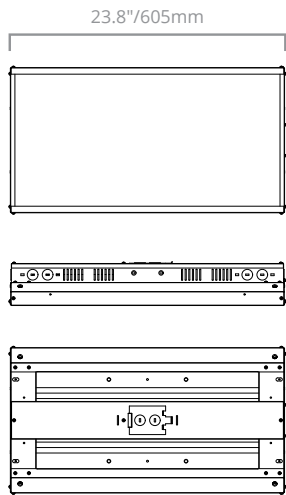

LLH-06D/1D/2D

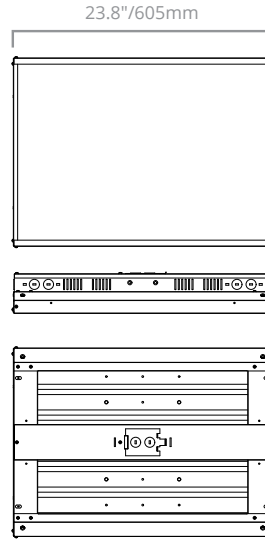

LLH-3D

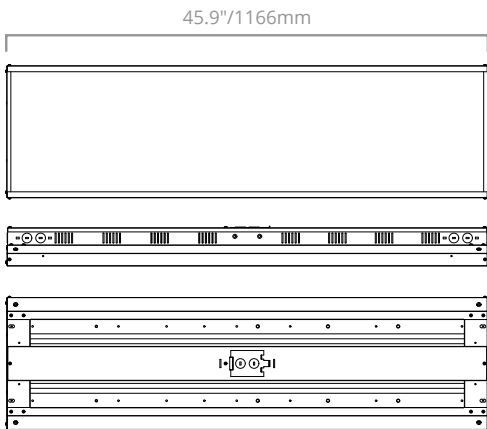

LLH-4D/5D

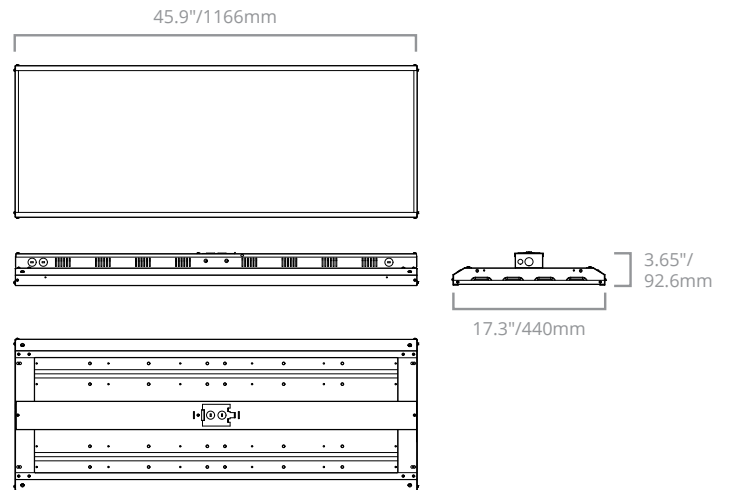

LLH-7D

FIXTURE SIZE CROSS REFERENCE

Fixture sizes are different; please refer to chart below for current fixture size.

| LLH-C SERIES | Fixture Size | LLH-D SERIES | | | | | | |
|--------------|--------------|--------------|----|----|----|----|----|----|
| | | 06D | 1D | 2D | 3D | 4D | 5D | 7D |
| 1C | 1x2 | ✖ | ✖ | ✖ | | | | |
| 2C | 1.5x2 | | | | ✖ | | | |
| 3C | 1x4 | | | | | ✖ | ✖ | |
| 4C | 1.5x4 | | | | | | | ✖ |
| 5C | | | | | | | | |

*For reference only; refer to performance summary above for fixture performance.

PHOTOMETRICS

LLH-06D-xxK-y

| ZONAL LUMEN SUMMARY | | |
|---------------------|---------|----------|
| Zone | Lumens | %Fixture |
| 0-30 | 2415.38 | 29.8% |
| 0-40 | 3925.65 | 48.4% |
| 0-60 | 6674.89 | 82.4% |
| 0-80 | 7968.02 | 98.3% |
| 0-90 | 8066.81 | 100% |
| 0-180 | 8105.08 | 100% |

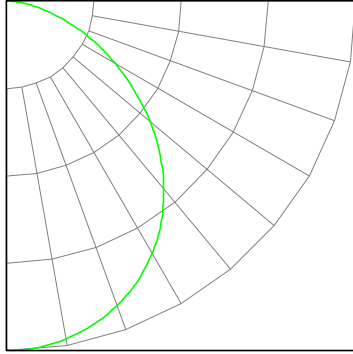

LLH-1D-xxK-y

| ZONAL LUMEN SUMMARY | | |
|---------------------|----------|----------|
| Zone | Lumens | %Fixture |
| 0-30 | 4124.4 | 29.8% |
| 0-40 | 6690.37 | 48.3% |
| 0-60 | 11369.92 | 82.1% |
| 0-80 | 13618.25 | 98.4% |
| 0-90 | 13797.97 | 100% |
| 0-180 | 13841.93 | 100% |

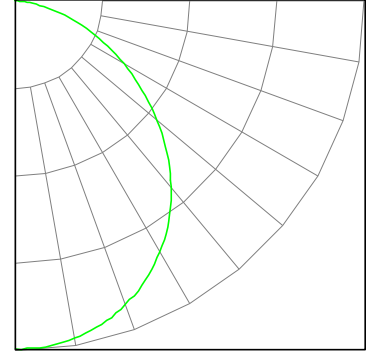

LLH-2D-xxK-y

| ZONAL LUMEN SUMMARY | | |
|---------------------|----------|----------|
| Zone | Lumens | %Fixture |
| 0-30 | 6085.76 | 30.0% |
| 0-40 | 9850.05 | 48.6% |
| 0-60 | 16662.35 | 82.2% |
| 0-80 | 19931.55 | 98.3% |
| 0-90 | 20202.57 | 100% |
| 0-180 | 20273.93 | 100% |

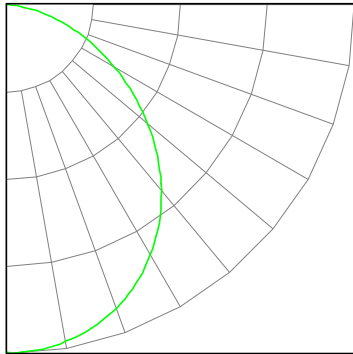

LLH-3D-xxK-y

| ZONAL LUMEN SUMMARY | | |
|---------------------|----------|----------|
| Zone | Lumens | %Fixture |
| 0-30 | 8224.91 | 29.9% |
| 0-40 | 13331.08 | 48.5% |
| 0-60 | 22593.37 | 82.2% |
| 0-80 | 27035.74 | 98.3% |
| 0-90 | 27392.8 | 100% |
| 0-180 | 27496.39 | 100% |

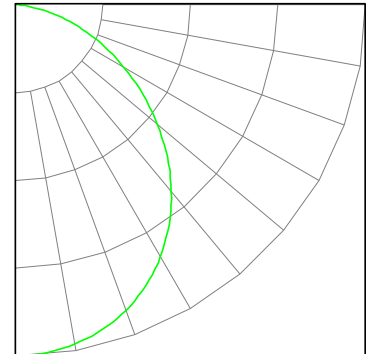

LLH-4D-xxK-y

| ZONAL LUMEN SUMMARY | | |
|---------------------|----------|----------|
| Zone | Lumens | %Fixture |
| 0-30 | 10218.99 | 29.8% |
| 0-40 | 16619.88 | 48.5% |
| 0-60 | 28250.23 | 82.5% |
| 0-80 | 33703.2 | 98.4% |
| 0-90 | 34124.94 | 100% |
| 0-180 | 34253.9 | 100% |

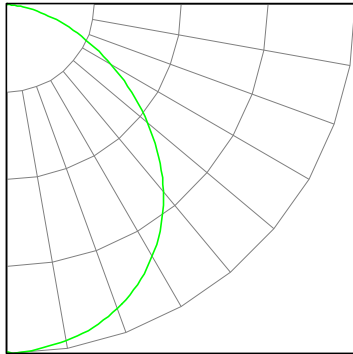

LLH-5D-xxK-y

| ZONAL LUMEN SUMMARY | | |
|---------------------|----------|----------|
| Zone | Lumens | %Fixture |
| 0-30 | 11957.77 | 29.8% |
| 0-40 | 19397.12 | 48.4% |
| 0-60 | 32941.45 | 82.2% |
| 0-80 | 39411.08 | 98.4% |
| 0-90 | 39927.84 | 100% |
| 0-180 | 40067.53 | 100% |

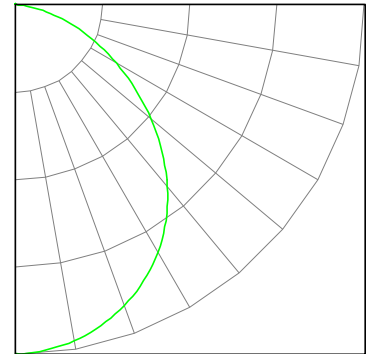

LLH-7D-xxK-y

| ZONAL LUMEN SUMMARY | | |
|---------------------|----------|----------|
| Zone | Lumens | %Fixture |
| 0-30 | 16296.36 | 29.7% |
| 0-40 | 26494.6 | 48.2% |
| 0-60 | 45140.66 | 82.2% |
| 0-80 | 54066.22 | 98.4% |
| 0-90 | 54795.46 | 100% |
| 0-180 | 54931.57 | 100% |

